

Sockets & Accessories

■ DIN-Rail Socket Ordering Information

P Y F - 11 A E

Safeguard:
(安全型態)

Nil: Without Finger Protection
E: With Finger Protection

Area Specification:
(地區規格)

A: Asia Specification
B: Europe Specification

Effective Holes:
(有效孔數)

08: 8 Holes
11: 11 Holes
14: 14 Holes

Install Type:
(安裝類型)

F: DIN-Rail Install

Suit Relay Model:
(適用 Relay)

Y: RE Model
T: RET Model

Item:

P: Socket

◇ PLF DIN-Rail Socket Ordering Information

P L F - X 03

Coil Operation Voltage:

03: 3V, **04:** 4.5V, **05:** 5V, **06:** 6V, **09:** 9V, **12:** 12V,
15: 15V, **18:** 18V, **24:** 24V, **48:** 48V, **60:** 60V

Internal Connections:

X: Diode + LED, Positive Pole "+" on A1 Terminal
V: Diode + LED, Negative Pole "-" on A1 Terminal

Install Type:

F: DIN-Rail Install with Screw Type Terminals
S: DIN-Rail Install with Screwless Type Terminals

Suit Relay Model:

L: LR Model

Item:

P: Socket

◇ DIN-Rail Socket List

No	Socket Name	Suit Relay Model	Note
1	PYF-08A	RE-2P	
2	PYF-08AE	RE-2P	
3	PYF-08BE	RE-2P	
4	PYF-08BE/3	RE-2P	/3: Conform to VDE0160
5	PYF-14A	RE-4P	
6	PYF-14AE	RE-4P	
7	PYF-14BE	RE-4P	
8	PYF-14BE/3	RE-4P	/3: Conform to VDE0160
9	PTF-08A	RET-1P, RET-2P	
10	PTF-08AE	RET-1P, RET-2P	
11	PTF-14A	RET-4P	
12	PTF-14AE	RET-4P	
13	PLF-X□□	LR	□□ for Coil Operation Voltage
14	PLF-V□□	LR	□□ for Coil Operation Voltage
15	PLS-X□□	LR	□□ for Coil Operation Voltage
16	PLS-V□□	LR	□□ for Coil Operation Voltage

◇ Other-1 DIN-Rail Socket Ordering Information

P F - 083 A E

Safeguard:
(安全型態)

Nil: Without Finger Protection
E: With Finger Protection

Area Specification:
(地區規格)

A: Asia Specification
B: Europe Specification

Suit Relay Model:
(適用 Relay)

083: RK-2P Model
113: RK-3P Model

Install Type:

F: DIN-Rail Install

Item:

P: Socket

◇ Other DIN-Rail Socket List

No	Socket Name	Suit Relay Model	Note
1	PF-083A	RK-2P	
2	PF-083AE	RK-2P	
3	PF-083BE	RK-2P	
4	PF-113A	RK-3P	
5	PF-113AE	RK-3P	
6	PF-113BE	RK-3P	
7	PF-113BE/3	RK-3P	

Sockets & Accessories

◇ Other-2 DIN-Rail Socket Ordering Information

P I -35 B E /3	Insulation high:	Nil: Standard high /3: Conform to VDE0160
	Safeguard:	Nil: Without Finger Protection E: With Finger Protection
	Area Specification:	A: Asia Specification B: Europe Specification
	Suit Dimension:	-35: 3.5mm -50: 5.0mm
	Suit Relay Model:	I: EMI, EZ Model P: Socket
	Item:	

◇ Other-2 DIN-Rail Socket List

No	Socket Name	Suit Relay Model	Note
1	PI-35BE	EMI-1P, MI-1P	
2	PI-35BE/3	EMI-1P, MI-1P	/3: Conform to VDE0160
3	PI-50BE	EMI-2P, MI-2P, EZ, EZI	
4	PI-50BE/3	EMI-2P, MI-2P, EZ, EZI	/3: Conform to VDE0160

■ Simple Socket Ordering Information:

P I - 35 - 0	Suit State:	Nil: for Socket Terminal Socket 0: for PCB Terminal Socket
	Effective Holes and Suit Dimension:	05: 5 Holes 08: 8 Holes 11: 11 Holes 14: 14 Holes 35: 3.5mm 50: 5.0mm
	Suit Relay Model:	Y: RE Model T: RET Model I: EMI, EZ Model L: LR Model
	Item:	P: Socket

◇ Simple Socket List

No	Socket Name	Suit Relay Model	Note
1	PY-08	RE-2P	Socket Terminal
2	PY-08-0	RE-2P	PCB Terminal
3	PY-14	RE-4P	Socket Terminal
4	PY-14-0	RE-4P	PCB Terminal
5	PT-08	RET-1P, RET-2P	Socket Terminal
6	PT-08-0	RET-1P, RET-2P	PCB Terminal
7	PI-35-0	EMI-1P, MI-1P	PCB Terminal
8	PI-50-0	EMI-2P, MI-2P, EZ, EZI	PCB Terminal
9	PL-05-0	LR	PCB Terminal

◇ Other Type Socket

No	Socket Name	Suit Relay Model	Note
1	UC3003	GRL	With Wire Terminals, Side Interlock Type
2	CS3770	GRL	With Wire Terminals, Independent Type
3	UC3001	GRL	PCB Terminal

Sockets & Accessories

Socket illustration

PYF-08A

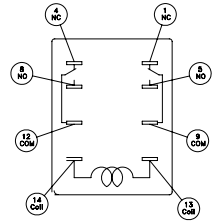

Terminal illustration



BS-36-M
Equipment

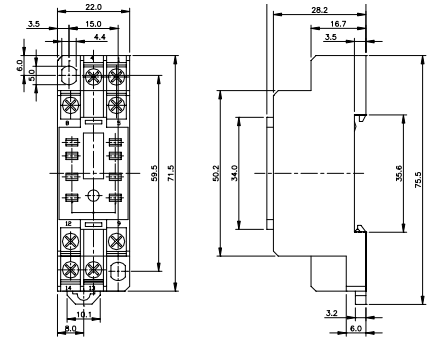

Appearance illustration



PYF-08AE

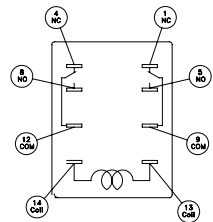

Terminal illustration



BS-36-M
Equipment

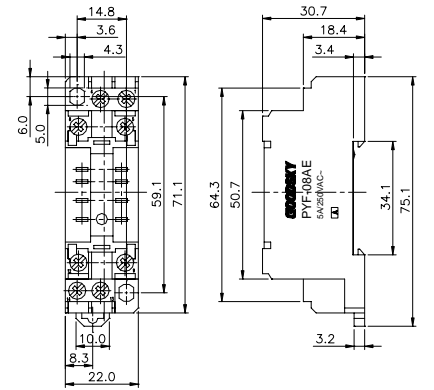

Appearance illustration

PYF-08BE

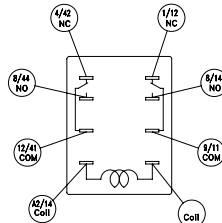

Terminal illustration

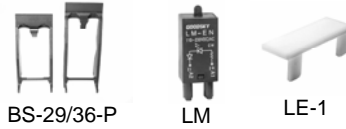

BS-29/36-P
LM
LE-1
Equipment

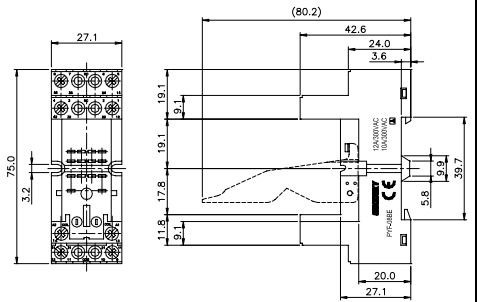

Appearance illustration

PYF-08BE/3

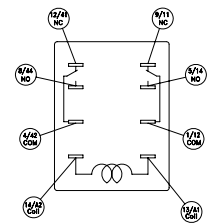

Terminal illustration

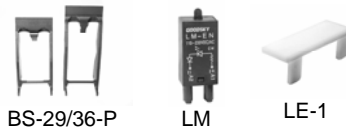

BS-29/36-P
LM
LE-1
Equipment

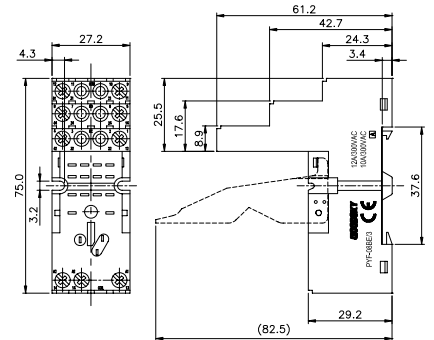

Appearance illustration

Sockets & Accessories

Socket illustration

PYF-14A

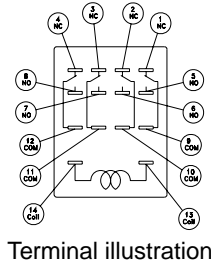

Terminal illustration



BS-36-M

Equipment

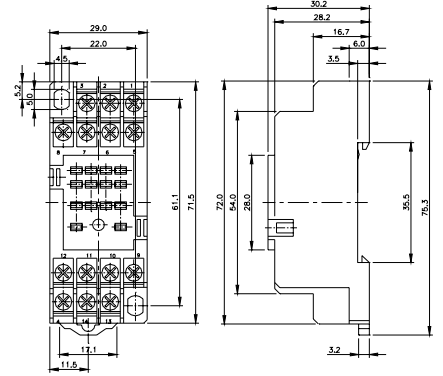

Appearance illustration

PYF-14AE

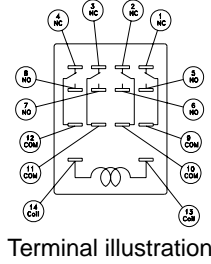

Terminal illustration



BS-36-M

Equipment

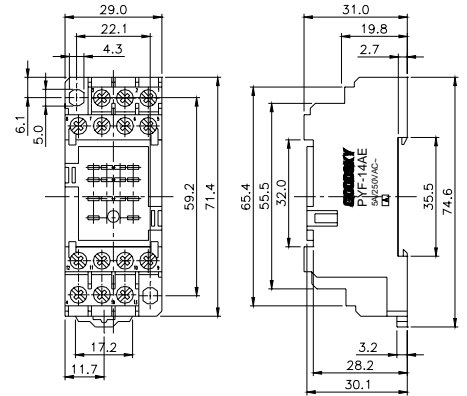

Appearance illustration

PYF-14BE

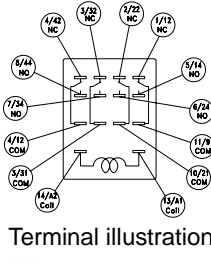

Terminal illustration

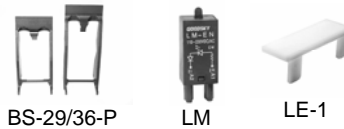

BS-29/36-P

LM

LE-1

Equipment

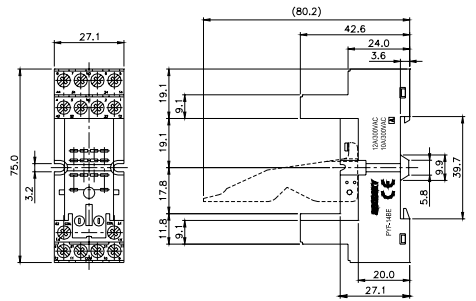

Appearance illustration

PYF-14BE/3

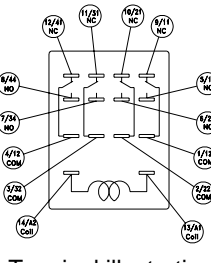

Terminal illustration

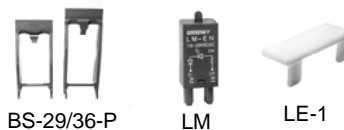

BS-29/36-P

LM

LE-1

Equipment

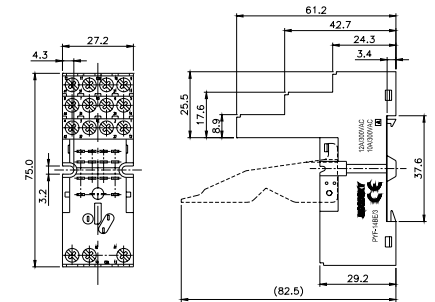

Appearance illustration

Sockets & Accessories

Socket illustration

PTF-08A

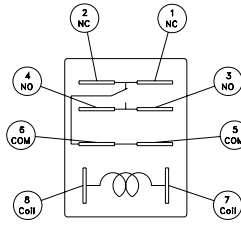

Terminal illustration



BS-36-M
Equipment

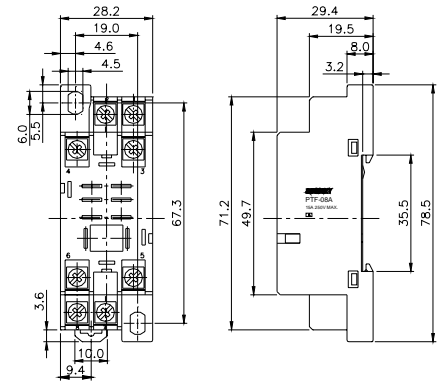

Appearance illustration

PTF-08AE

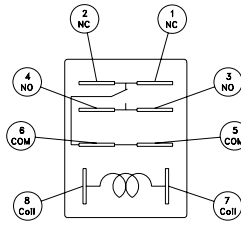

Terminal illustration



BS-36-M
Equipment

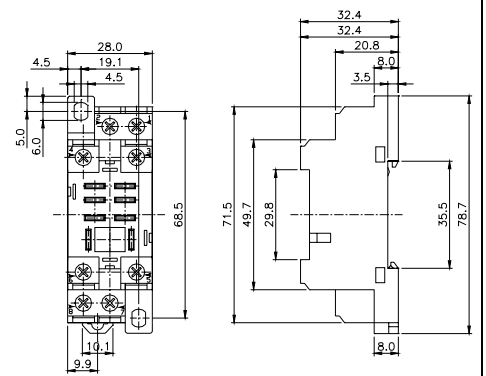

Appearance illustration



PTF-14A

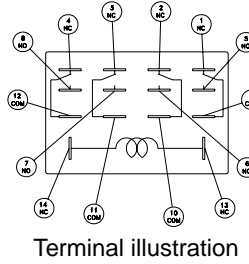

Terminal illustration



BS-36-M
Equipment

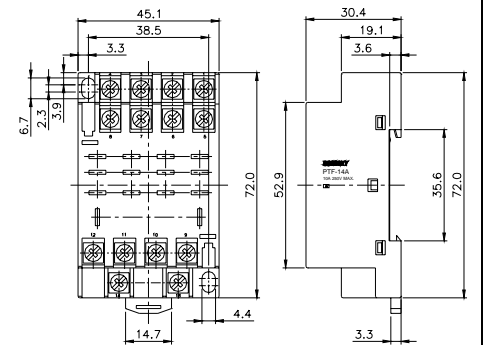

Appearance illustration

PTF-14AE

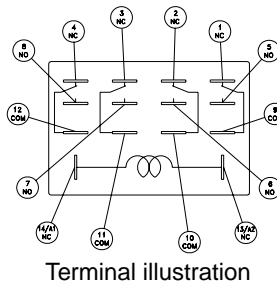

Terminal illustration



BS-36-M
Equipment

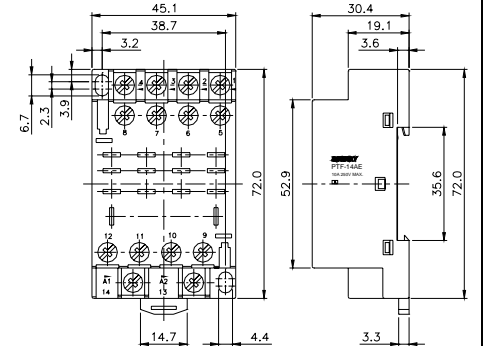

Appearance illustration

Sockets & Accessories

Socket illustration

PLF

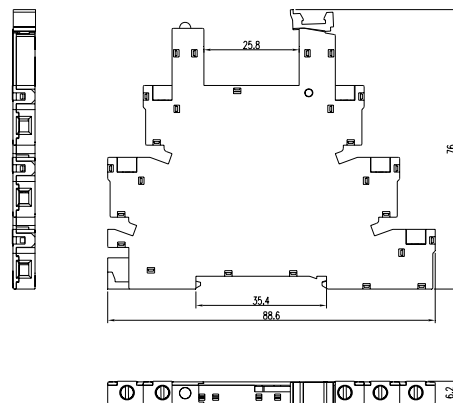

Appearance illustration

PF-083A

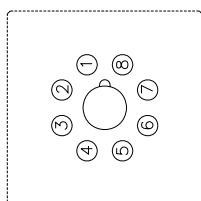
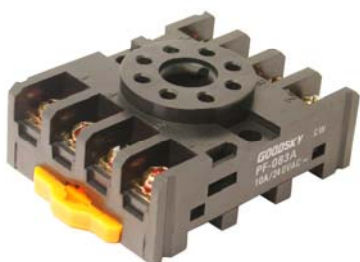

Terminal illustration



BS-50-M

Equipment

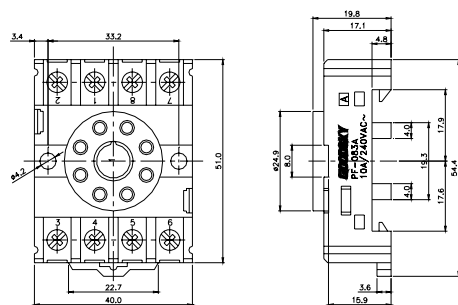

Appearance illustration

PF-083AE

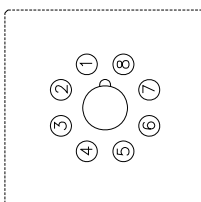

Terminal illustration



BS-50-M

Equipment

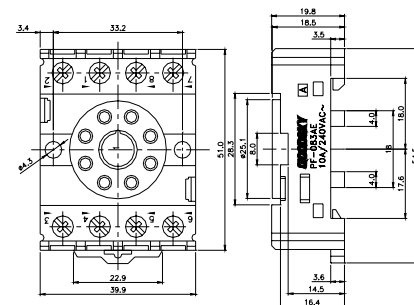

Appearance illustration

PF-083BE

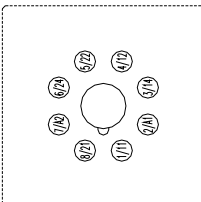

Terminal illustration



BS-50-MS

Equipment

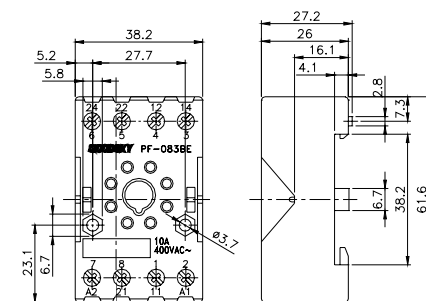

Appearance illustration

Sockets & Accessories

Socket illustration

PF-113A

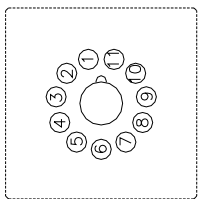

Terminal illustration



BS-50-M

Equipment

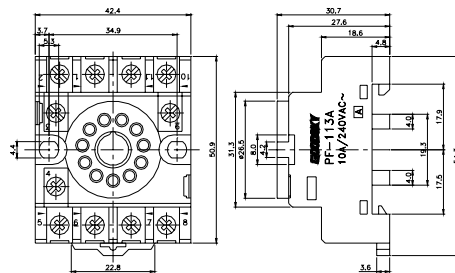

Appearance illustration

PF-113AE

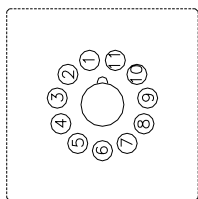

Terminal illustration



BS-50-M

Equipment

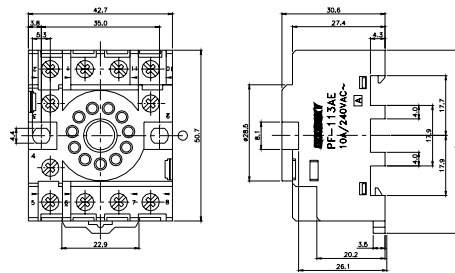

Appearance illustration

PF-113BE

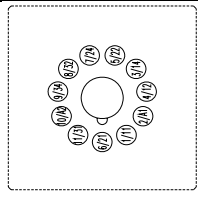

Terminal illustration



BS-50-MS

Equipment

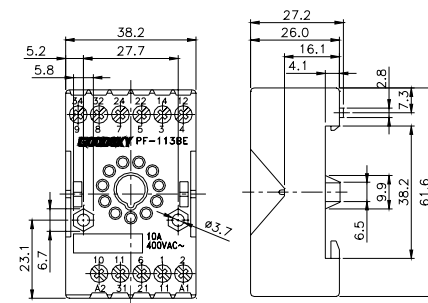

Appearance illustration

PF-113BE/3

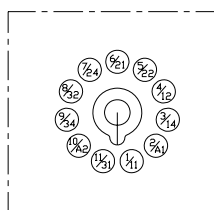

Terminal illustration



BS-50-MS



LM

Equipment

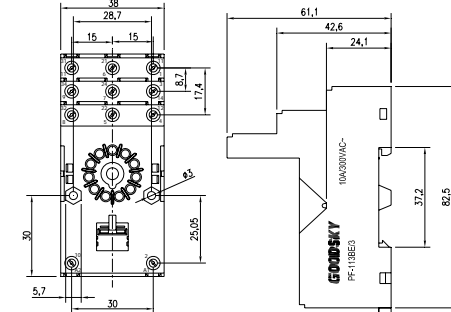

Appearance illustration

Sockets & Accessories

Socket illustration

PI-35BE

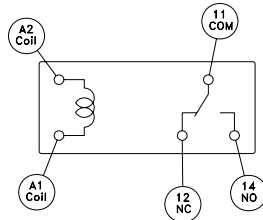

Terminal illustration

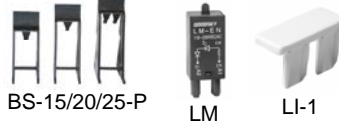

BS-15/20/25-P

LM

LI-1

Equipment

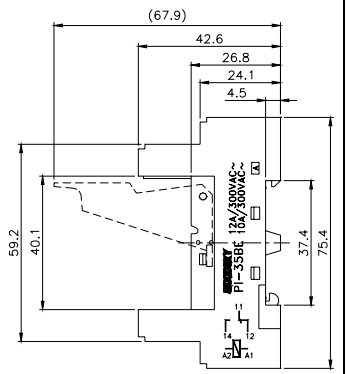
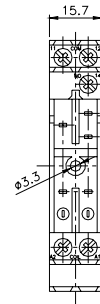

Appearance illustration

PI-35BE/3

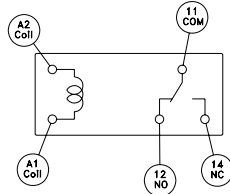

Terminal illustration

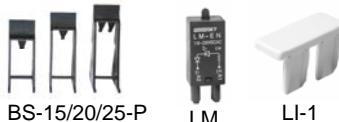

BS-15/20/25-P

LM

LI-1

Equipment

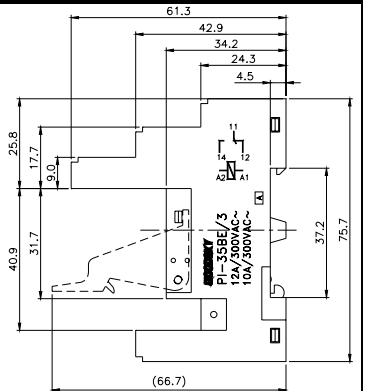
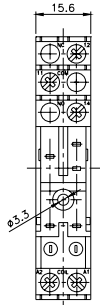

Appearance illustration

PI-50BE

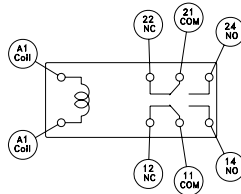

Terminal illustration

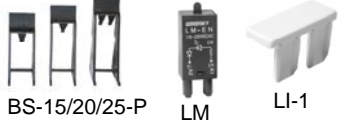

BS-15/20/25-P

LM

LI-1

Equipment

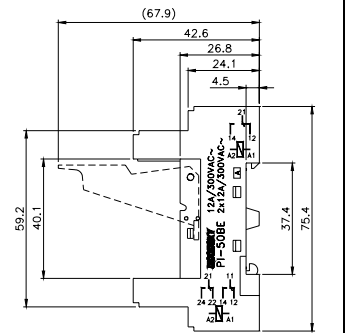
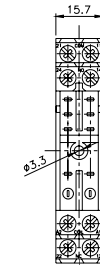

Appearance illustration

PI-50BE/3

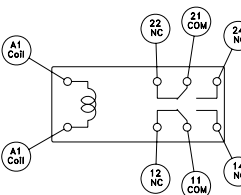

Terminal illustration



BS-15/20/25-P

LM

LI-1

Equipment

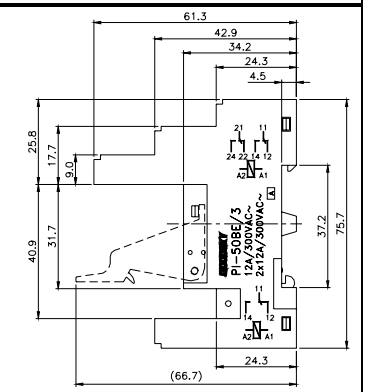
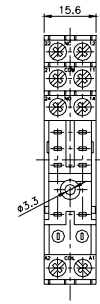

Appearance illustration

Sockets & Accessories

Socket illustration

PY-08



BP-36-MS
Equipment

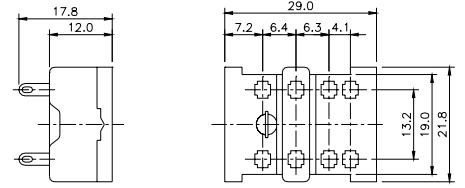

Appearance illustration

PY-08-0

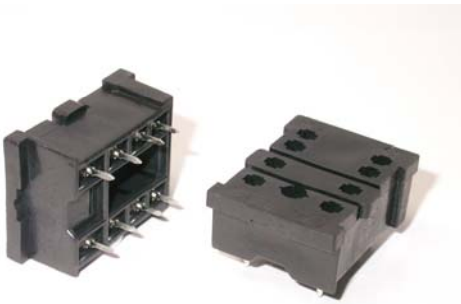

BP-36-MS
Equipment

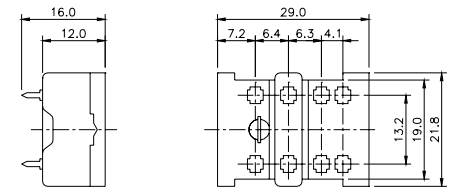

Appearance illustration

PY-14



BP-36-MS
Equipment

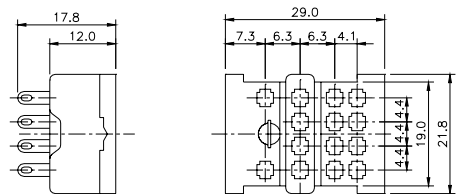

Appearance illustration

PY-14-0

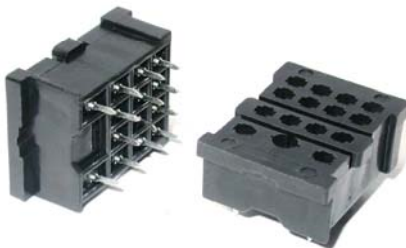

BP-36-MS
Equipment

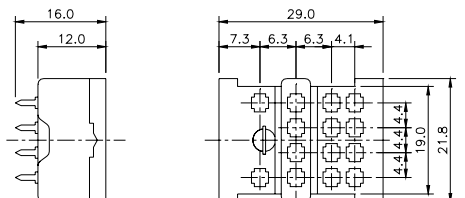

Appearance illustration

Sockets & Accessories

Socket illustration

PT-08



BP-36-MS

Equipment

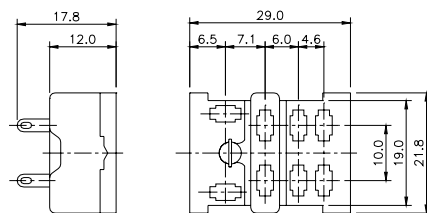

Appearance illustration

PT-08-0



BP-36-MS

Equipment

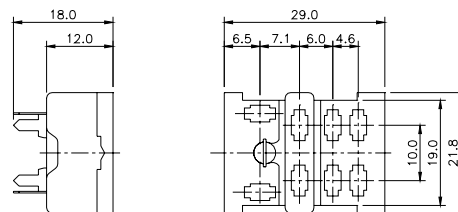

Appearance illustration

PI-35-0



BP-15/20/25-MS
(15/20/25mm)

(Metal)



BP-15/20/25-PS
(15/20/25mm)

(Plastic)

Equipment

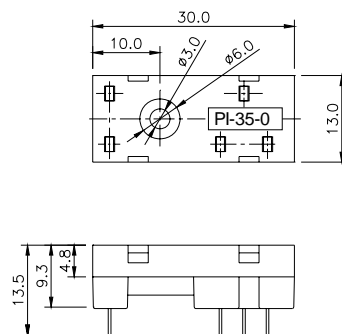

Appearance illustration

PI-50-0



BP-15/20/25-MS
(15/20/25mm)

(Metal)



BP-15/20/25-PS
(15/20/25mm)

(Plastic)

Equipment

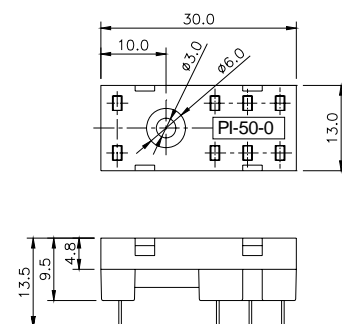

Appearance illustration

Sockets & Accessories

Socket illustration

UC3003

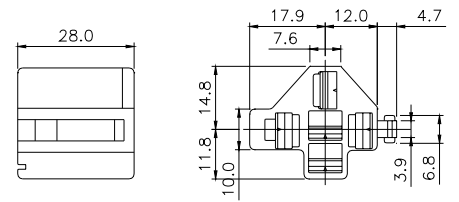

Appearance illustration

CS3770

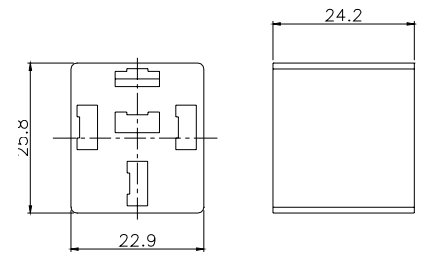

Appearance illustration

UC3001

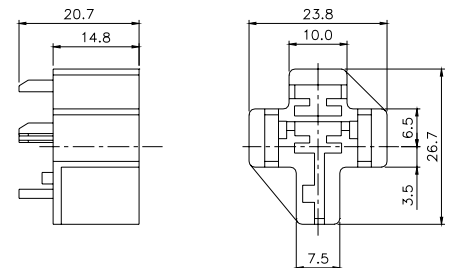
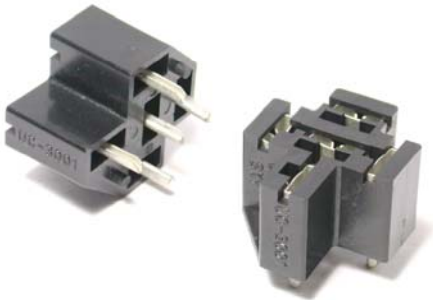

Appearance illustration

■ Retaining Clip for Sockets Ordering Information

B	P	-15	-P	S	
					Retainer Type: Nil: For PYF-xxA, PYF-xxBE, PTF-xxA, PF-xxA, PI-xxBE S: For PF-xxBE, PY, PT, PI-xx-0
					Material: P: Plastic M: Metal
					Suit Relay High: -15: 15.0~16.5mm -20: 20.0~20.5mm -25: 25.0~25.5mm -29: 29mm (for PYF) -36: 34.6~35.7mm (for PYF, PTF, PY, PT) -50: 50mm (for PF)
					Socket Type: P: PCB Socket S: DIN-Rail Socket
					Item: B: Retaining Clip

Sockets & Accessories

LED Module

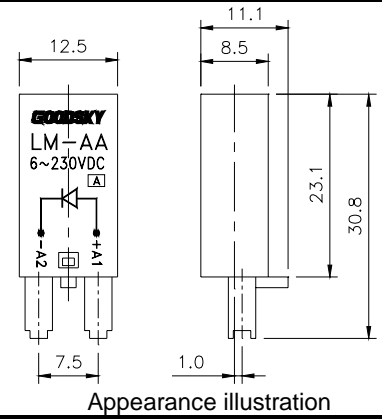

Appearance illustration

LED Module Wiring Diagrams

AC	AB	BC	BD	BE	CF	CG
6/230 V DC 	6/230 V DC 	6/24 V DC 	24/60 V DC 	110/230 V DC 	6/24 V DC 	24/60 V DC
CH	DI	DJ	DK	EL	EM	EN
110/230 V AC 	6/24 V AC 	24/60 V AC 	110/240 V AC 	6/24 V AC/DC 	24/60 V AC/DC 	110/230 V AC/DC
FO	FP	FQ	FR	GR	GS	GT
6/24 V AC/DC 	24/60 V AC/DC 	110/230 V AC/DC 	12/48 V AC/DC 	24 V AC 	115 V AC 	230 V AC
HU	JV	JW	JX			
110/230 V AC 	6/24 V AC/DC 	24/60 V AC/DC 	110/230 V AC/DC 			

LED Module Ordering Information

LM **-AC** **-G-**

LED Color: _____ **Nil:** Red
G: Green

Area Code: _____ **-AC, -AB**
-BC, -BD, -BE
-CF, -CG, -CH
-DI, -DJ, -DK
-EL, -EM, -EN
-FO, -FP, -FQ, FR
-GR, -GS, -GT
-HU
JV, JW, JX

Produce Name: _____ **LM:** LED Module

Identification Board

L **E** **-1**

Type: _____ **1:** Standard Type
Suit Socket Model: _____ **E:** PYF-BE Model
I: PI-BE Model
Product Name: _____ **L:** Identification Board