

REV	LTR	DESCRIPTION	DATE	APPROVED
A0				

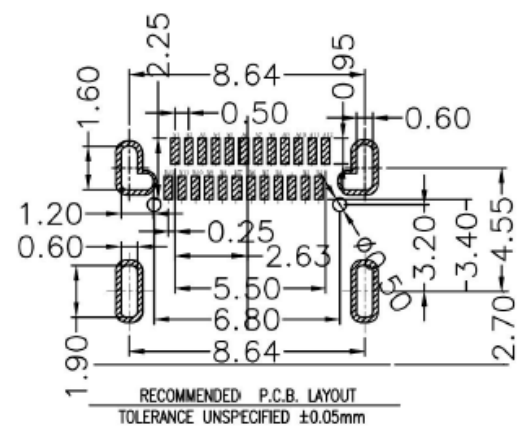
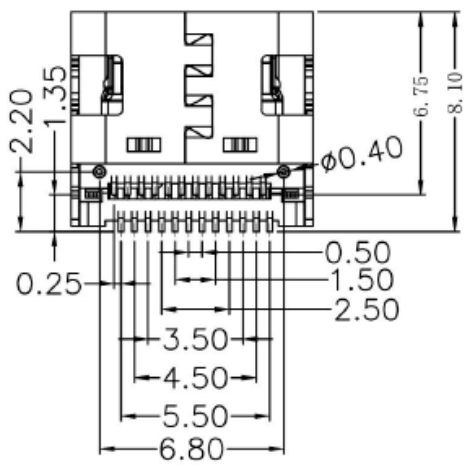
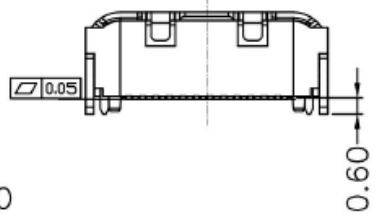
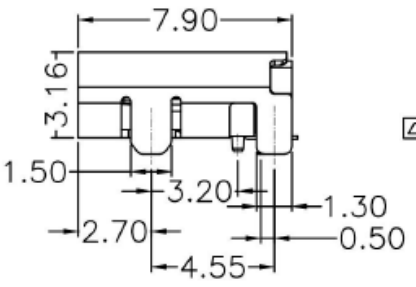
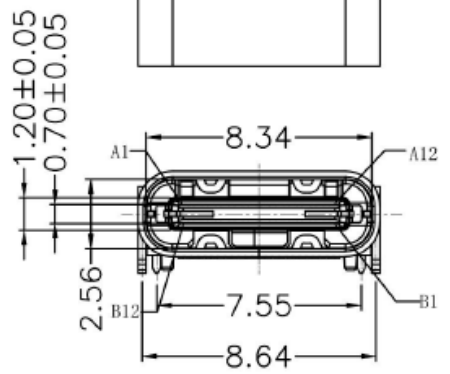
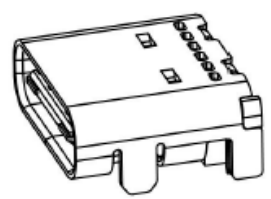
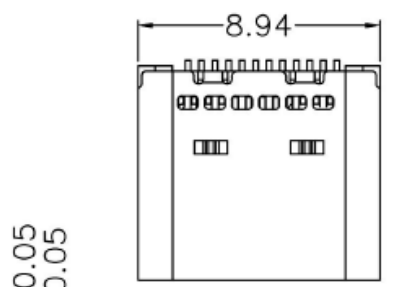

ITEM:USB3.1 TYPE-C 24PF-014

<p>TOLERANCES</p> <p>. X ±0.30</p> <p>. XX ±0.20</p> <p>. XXX ±0.10</p> <p>ANGLES ±1.00°</p>		RUI CHI		
<p>APPD. :</p>		DRAWING NO. : 812039-079		
<p>CHECK :</p>				
<p>DRAWN :</p>		REV. :	SIZE :	UNIT :
		A/0	A4	M M
		SCALE :	SHEET :	
		1 : 1	1 / 1	