

REV.	DESCRIPTION	DRAWN	CHECKED	APPROVED
A	NEW RELEASE	LJH 08/13/05'		

BOM LIST			
ITEM	PART NAME	Q'ty	NOTES
1	PLASTIC HOOD	2	ABS
2	BOLT	2	#4-40
3	NUT	2	M3
4	LONG SCREW	2	M3
5	SMALL WASHER	2	
6	SHORT SCREW	2	M3
7	MIDDLE WASHER	2	M3

NOTES:
1. PART NUMBER CODE:
DS1046 - 09 X X X

Bolt type
L: Long
S: Short

Packing type
1: Mix packing
2: Separation packing

Cover Material
C: Chromium Plated

Positions
09: 9pin

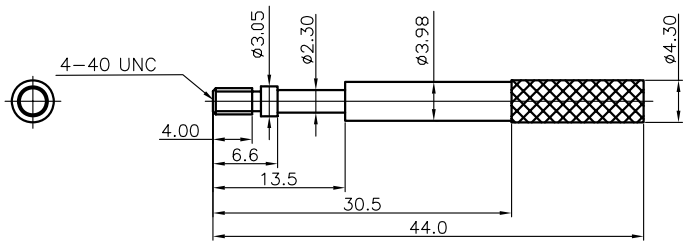
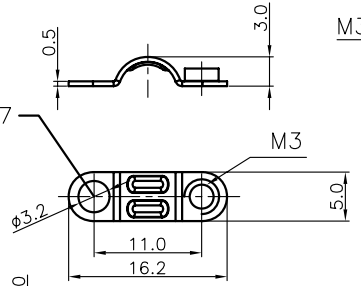
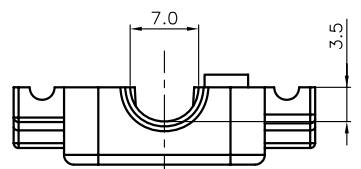
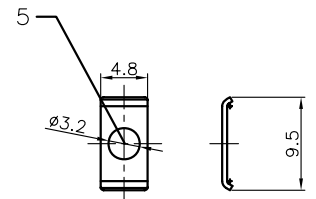
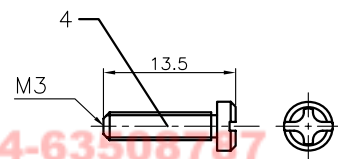
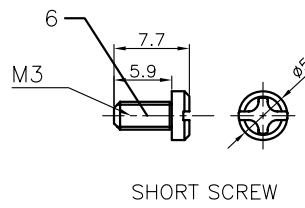
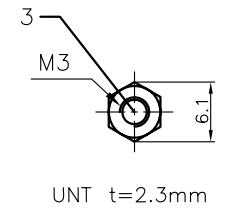
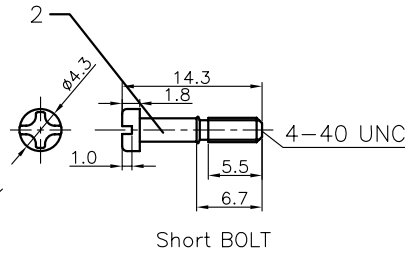
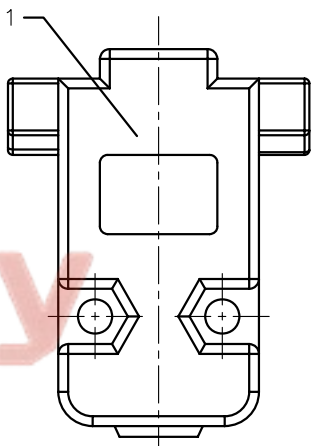
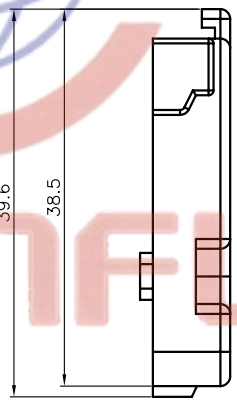
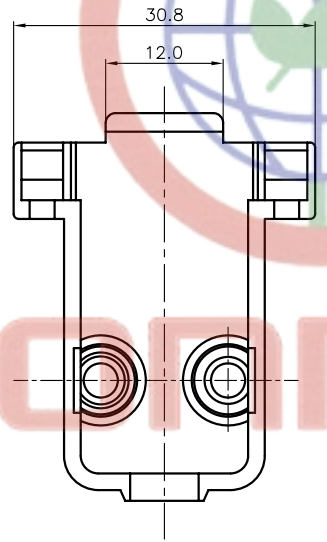
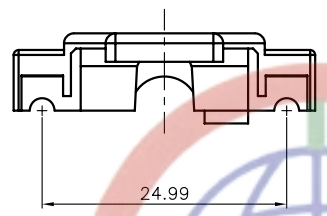
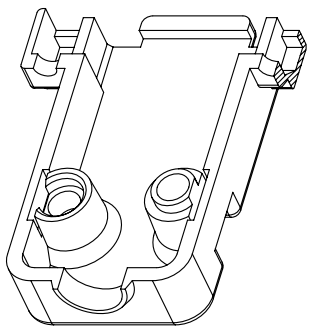

Tel: 86-574-63508707
Fax: 86-574-63510817

GENERAL TOLERANCE		ANGLE TOLERANCE		PROJECTION	TITLE
X. ±0.60	.X ±0.38	.X ±5°	.X ±3°	mm	D-SUB 9pin Cover Chromium Plated
.XX ±0.25		.XX ±2°			SERIES DS1046 SERIES
DRAWING TYPE	CUSTOMER	Add: West Lake No. 11, Hangzhou, China			
SCALE	1:1	SHEET	1 OF 1		
DRAWING NO.	C-DS1046-09XXX				

晨翔电子有限公司
CONNFLY CONNFLY ELECTRONIC CO. LTD

REV.	DESCRIPTION	DRAWN	CHECKED	APPROVED
A	NEW RELEASE	LJH 05/18/05'		

NOTES:

1. PART NUMBER CODE:
DS1046 - 15 X X X

Bolt type
L: Long
S: Short

Packing type
1: Mix packing
2: Separation packing

Cover Material
C: Chromium Plated

Positions
15: 15pin

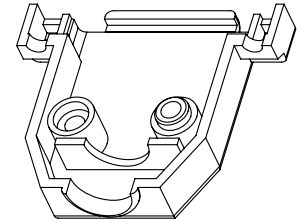

BOM LIST			
ITEM	PART NAME	Q'ty	NOTES
1	PLASTIC HOOD	2	ABS
2	BOLT	2	#4-40
3	NUT	2	M3
4	LONG SCREW	2	M3
5	SMALL WASHER	2	
6	SHORT SCREW	2	M3
7	MIDDLE WASHER	2	M3

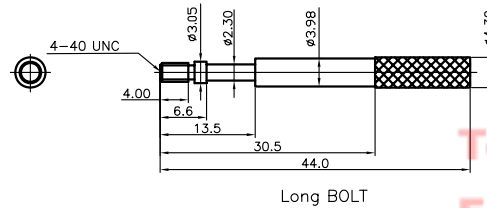
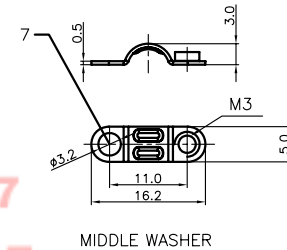
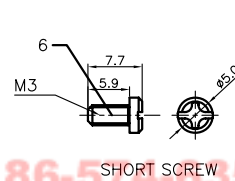
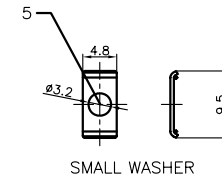
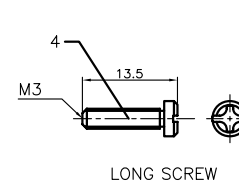
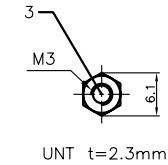
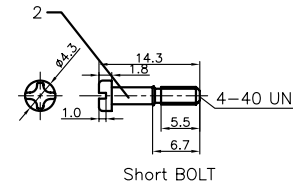
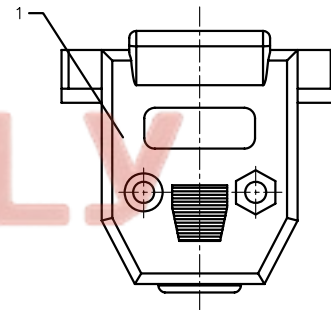
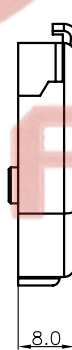
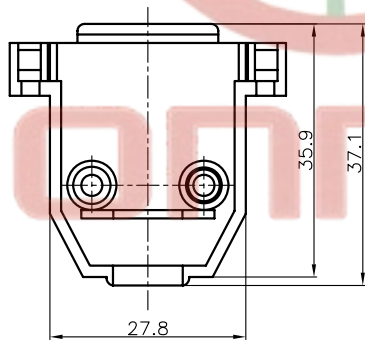
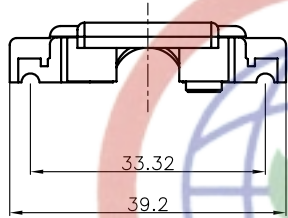

Tel: 86-574-63508787
Fax: 86-574-63510817

GENERAL TOLERANCE		ANGLE TOLERANCE		PROJECTION	TITLE
X.	±0.60	X.	±5°	mm	D-SUB 15pin Cover Chromium Plated
.X	±0.38	.X	±3°		SERIES DS1046 SERIES
.XX	±0.25	.XX	±2°		
DRAWING TYPE	COSTOMER		Add: West China Gx Ni Jia China		
SCALE	1:1	SHEET	1 OF 1		
DRAWING NO.	C-DS1046-15XXX		CONFLY CONFLY ELECTRONIC CO. LTD		



晨翔电子有限公司

CONFLY CONFLY ELECTRONIC CO. LTD

REV.	DESCRIPTION	DRAWN	CHECKED	APPROVED
A	NEW RELEASE	LJH 10/26/05'		

BOM LIST			
ITEM	PART NAME	Q'ty	NOTES
1	PLASTIC HOOD	2	ABS
2	BOLT	2	#4-40
3	NUT	2	M3
4	LONG SCREW	2	M3
5	SMALL WASHER	2	
6	SHORT SCREW	2	M3
7	BIG WASHER	2	M3

NOTES:

1. PART NUMBER CODE:
DS1046 - 25 X X X

- Bolt type
L: Long
S: Short
- Packing type
1: Mix packing
2: Separation packing
- Cover Material
C: Chromium Plated
- Positions
25: 25pin

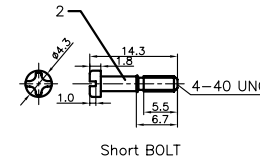
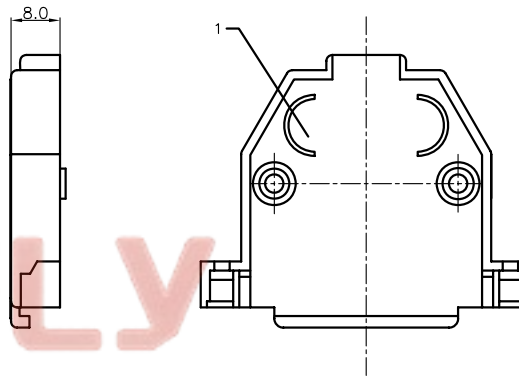
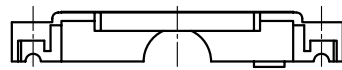
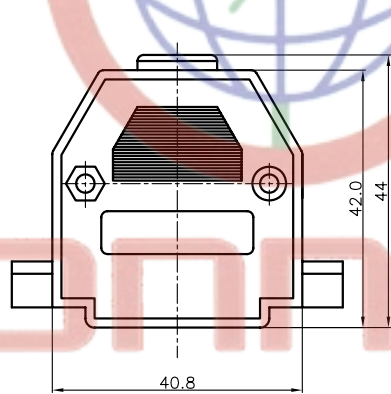
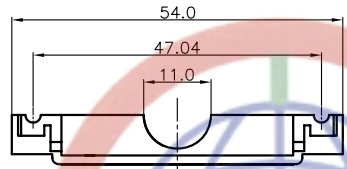

Short BOLT

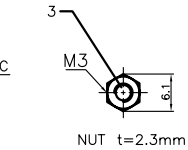

NUT t=2.3mm

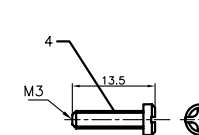

LONG SCREW

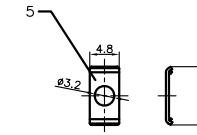

SMALL WASHER

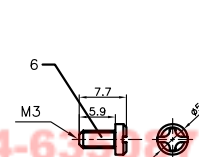

SHORT SCREW

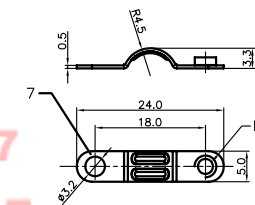

BIG WASHER

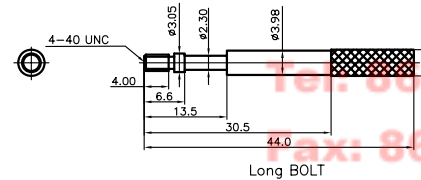

Long BOLT

GENERAL TOLERANCE		ANGLE TOLERANCE		PROJECTION	TITLE
X.	±0.60	X.	±5°	mm	D-SUB 25pin Cover Chromium plated
.X	±0.38	.X	±3°		
.XX	±0.25	.XX	±2°		
DRAWING TYPE		CUSTOMER		SHEET SIZE	SERIES
SCALE		1:1		A4	DS1046 SERIES
DRAWING NO.		C-DS1046-25XXX			

晨翔电子有限公司
CONNFLY CONNFLY ELECTRONIC CO. LTD

REV.	DESCRIPTION	DRAWN	CHECKED	APPROVED
A	NEW RELEASE	LJH 10/26/05'		

BOM LIST			
ITEM	PART NAME	Q'ty	NOTES
1	PLASTIC HOOD	2	ABS
2	BOLT	2	#4-40
3	NUT	2	M3
4	LONG SCREW	2	M3
5	SMALL WASHER	2	
6	SHORT SCREW	2	M3
7	BIG WASHER	2	M3

NOTES:

1. PART NUMBER CODE:
DS1046 - 37 X X X

- Bolt type
L: Long
S: Short
- Packing type
1: Mix packing
2: Separation packing
- Cover Material
C: Chromium Plated

Positions
37: 37pin

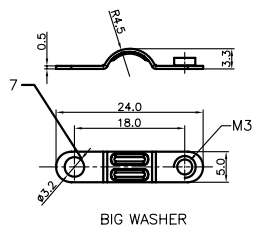
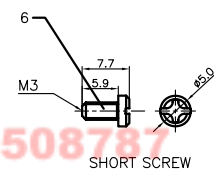
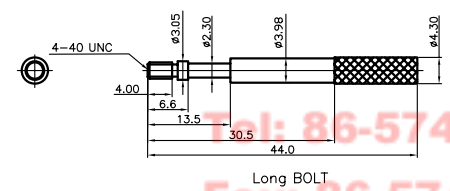
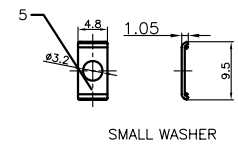
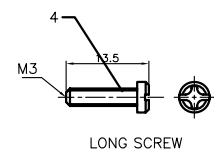
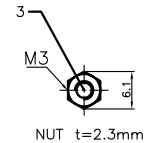
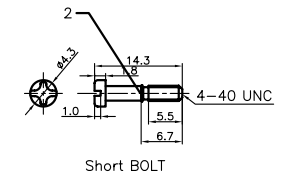
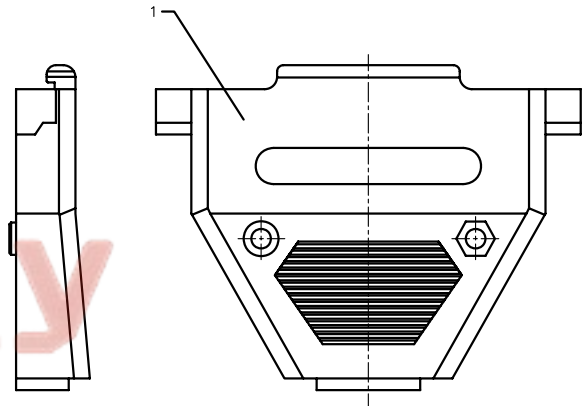
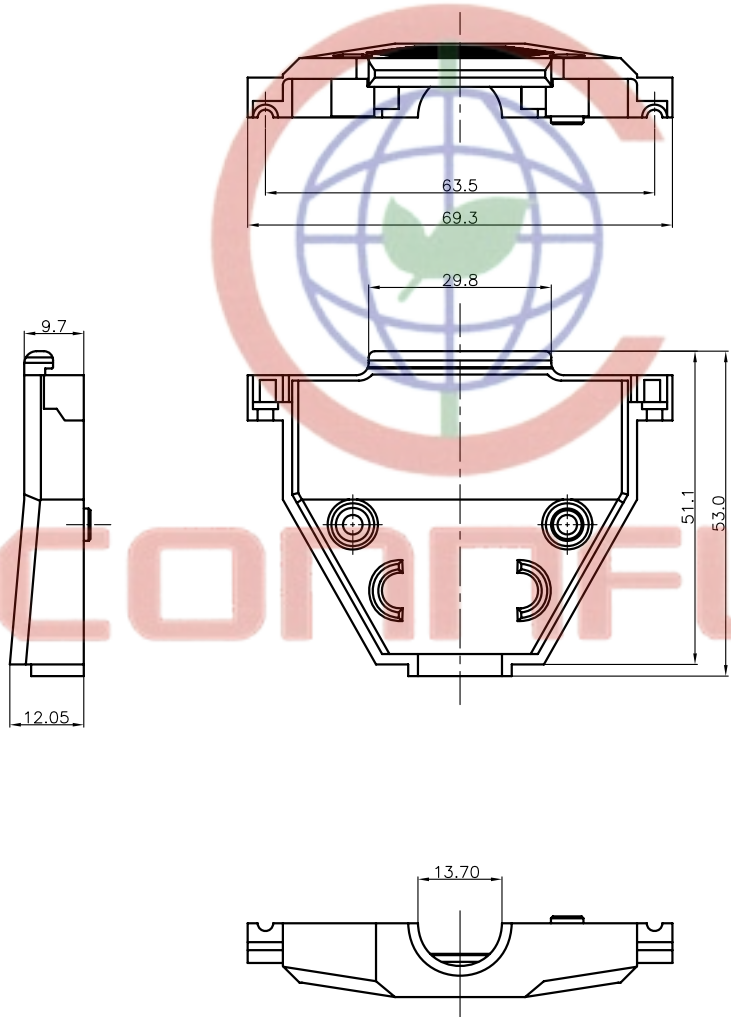
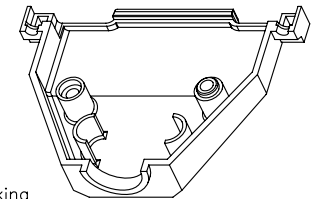

Tel: 86-574-63508787
Fax: 86-574-63510817

GENERAL TOLERANCE		ANGLE TOLERANCE		PROJECTION	TITLE
X.	±0.60	X.	±5°	mm	D-SUB 37pin Cover Chromium plated
.X	±0.38	.X	±3°	UNITS	
.XX	±0.25	.XX	±2°	SHEET SIZE	A4 SERIES DS1046 SERIES
DRAWING TYPE	COSTOMER		E-mail: 315521@cnng.com.cn		
SCALE	1:1	SHEET	1 OF 1		
DRAWING NO.	C-DS1046-37XXX		P.C.: 315521		



晨翔电子有限公司

CONNFLY CONNFLY ELECTRONIC CO. LTD