



### Технические характеристики

Диаметр контактов, мм	1	1,5	2	3
Сопротивление контактов, МОм, не более	15	10	5	3

Сопротивление изоляции в нормальных климатических условиях	5000 МОм
Максимальная токовая нагрузка	см. табл. 1
Максимальное рабочее напряжение (амплитудное значение)	см. табл. 1
Утечка воздуха при перепаде давления до 147099,8 Па (1,5 кгс/см <sup>2</sup> )	не допускается
Количество сочленений - расчленений	500
Минимальная наработка:	
с теплостойкостью 100 °С	1500 ч
с теплостойкостью 200 °С	1000 ч
Срок сохраняемости	15 лет
Соединители устойчивы к воздействию спецфакторов	

### Условия эксплуатации

<b>Механические факторы:</b>		<b>Климатические факторы:</b>	
<i>Синусоидальная вибрация:</i>		Повышенная рабочая	
Диапазон частот, Гц	5 - 5000	температура среды, С	100 или 200
Ускорение, м/с <sup>2</sup> (g)	500 (50)	Пониженная рабочая	
<i>Механический удар:</i>		температура среды, С	минус 60
Одиночного действия:		Атмосферное пониженное	
Ускорение, м/с <sup>2</sup> (g)	5000 (500)	давление, Па (мм рт. ст.)	1,34·10 <sup>-10</sup> (10 <sup>-12</sup> )
Множественного действия:			
Ускорение, м/с <sup>2</sup> (g)	1000 (100)		

### Минимальная наработка в зависимости от температуры соединителя









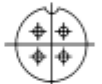

Минимальная наработка вилок с теплостойкостью 100 °С, ч	Минимальная наработка вилок с теплостойкостью 200 °С, ч	Температура соединителя, С
6	1000	250
-	2000	240
50	3000	230
-	4000	225
100	5000	220
200	25000	200
-	50000	190
500	100000	180
700		165
1500		150
2000		140
3000		130
4000		125
5000		120
25000		100
50000		90
100000		80





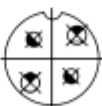





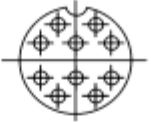

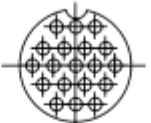

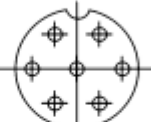

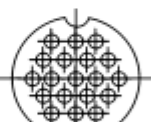

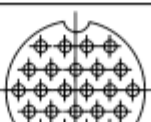

Примечание. Температура соединителя равна сумме рабочей температуры среды и температуры перегрева контактов.

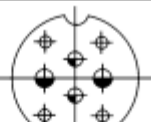



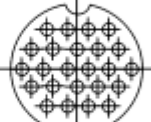

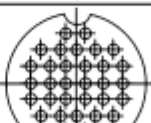

### Температура перегрева контактов в зависимости от токовой нагрузки

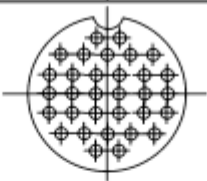

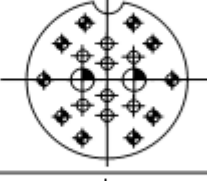



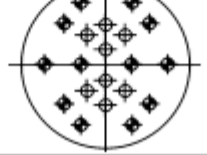



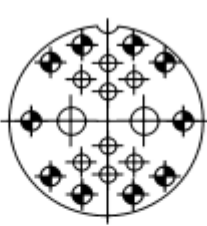

Токовая нагрузка на соединитель, в % от допустимой по ТУ	Температура перегрева контактов, С
120	80
110	60
100	50
85	40
75	30
60	25
50	20

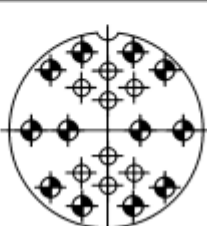

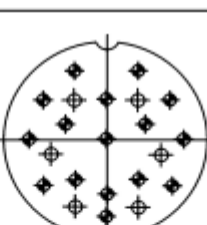

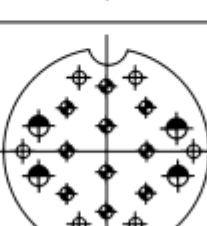

Таблица 1



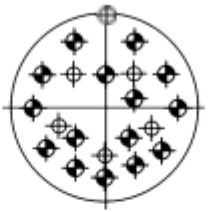



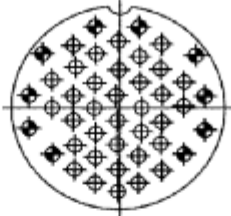

Условный размер корпуса	Тип соединителя	Схема расположения контактов	Условное обозначение контактов	Диаметр контактов, мм	Количество контактов, шт.	Обозначение сочетания контактов	Максимальная токовая нагрузка, А		Максимальное рабочее напряжение, В
							на одиночный контакт	суммарная на соединитель	
1	2	3	4	5	6	7	8	9	10
14	2РМГ			1	4	1	6	20	560
18	2РМГД			1,5	4	5	12	40	560
	2РМГ			1	7	1	5	30	560
22	2РМГ			2	2	3	13	55	560
				3	2		20	55	560
				1	10	1	5	42	560

24	2PMГ			1	19	1	4	63	560
	2PMГД			1,5	10	5	8	48	560
27	2PMГД			1,5	7	5	9	52	700
				1,5	19	5	6	95	560
	2PMГ			1	5	2	6	45	700
				1,5	2		12	45	700
				1	24	1	4	80	560
30	2PMГД			1,5	4	7	9	88	560
				2	2		12	88	560
				3	2		20	88	560
				1,5	24	5	5,5	110	560
	2PMГ			1	32	1	3	80	560

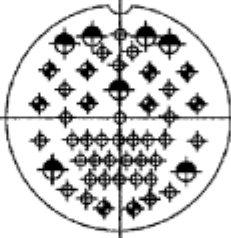
33	2PMГД			1,5	32	5	5	133	560
				1	8	4	4	76	560
				1	10		4	76	700
			3	2	20		76	560	
	2PMГ			1	8	1	4,5	75	560
				1	12		4,5	75	700

36	2PMГД			1,5	8	6	8	120	560
				1,5	10		8	120	700
				3	2		20	120	560
	2PMГД			1,5	8	5	7	116	560
				1,5	12		7	116	700
	2PMГ			1	5	1	4,5	82	560
				1	17		4,5	82	700
				1	6	2	4	80	560
				1	10		4	80	700
			1,5	4	8		80	560	

39	2PMГД			1,5	6	5	7	128	560
				1,5	16		7	128	700
	2PMГ			1	30	2	3	125	560
				1	10		3	125	700
				1,5	5		6	125	560

42	2PMГД			1,5	35	5	4	150	560
				1,5	10		4	150	700
	2PMГ			1	33	2	3	142	560
				1	10		3	142	700
				1,5	7		6	142	560
	2PMГ			1	15	2	3,5	130	700
				1,5	15		7	130	560

Вилки 2РМГ, 2РМГД



Таблица 2

Условный размер корпуса	Тип соединителя	мм				
		$d_{лев}$	A	B	b	$L_{max}$
14	2РМГ	M14x1	17	24	1,8	26,5
18	2РМГ, 2РМГД	M18x1	20	27	2,5	26,5
22	2РМГ	M22x1	23	30	1,8	28,5
24	2РМГ, 2РМГД	M24x1	26	33	2,5	26,5
27	2РМГ, 2РМГД	M27x1	29	36	2,5	26,5
30	2РМГ	M30x1	31	38	2,5	26,5
30	2РМГД	M30x1	31	38	2,5	26,5;28,5
33	2РМГ	M33x1	32	40	1,8	28,5
33	2РМГД	M33x1	32	40	1,8	26,5
36	2РМГ	M36x1	35	43	2,5	26,5
36	2РМГД	M36x1	35	43	2,5	26,5;28,5
39	2РМГ, 2РМГД	M39x1	37	46	1,8	26,5
42	2РМГ, 2РМГД	M42x1	40	49	2,5	26,5

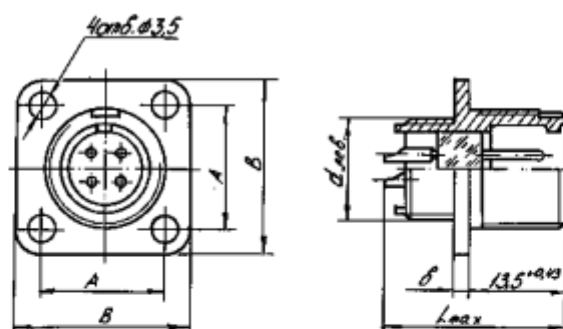

Патрубки прямые для экранированного кабеля

Таблица 3

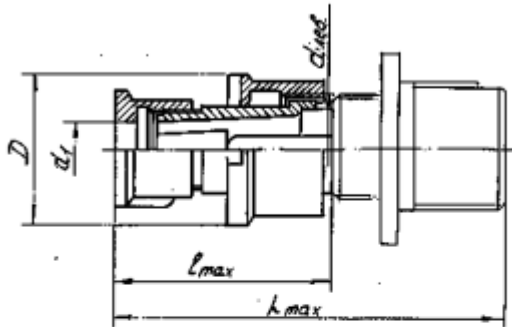
	$d_{лев}$	$d_1$	D	$l_{max}$	$L_{max}$
	M14x1	6,5	19	28,7	48
M18x1	10,5	22,5	28,7	48	
M22x1	14	27	28,7	48	
M24x1	16	29	34,7	54	
M27x1	18	32	34,7	54	
M30x1	19	36	34,7	54	
M33x1	23	39	39,7	59	
M36x1	23	42	39,7	59	
M39x1	24	45	39,7	59	
M42x1	29	48	39,7	59	

Патрубки прямые для неэкранированного кабеля

Таблица 4

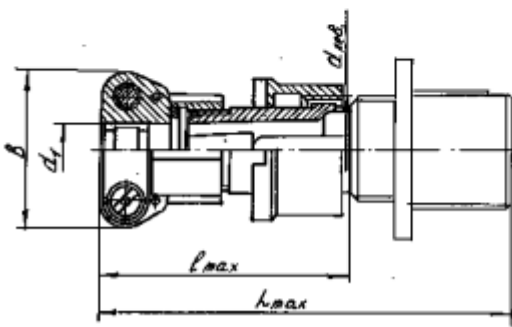
	$d_{лев}$	$d_1$	B	$l_{max}$	$L_{max}$
	M14x1	6,5	21	34	53,5
M18x1	10,5	25	36,5	55,5	
M22x1	14,5	32	43	55,5	
M24x1	16,6	34	43	55,5	
M27x1	18,5	36	43	62,5	
M30x1	20,5	38	43	62,5	
M33x1	22,5	41	48	67,5	
M36x1	22,5	41	48	67,5	
M39x1	24,5	30,5	48	67,5	
M42x1	30,5	36,5	48	67,5	