

Керамические изоляторы

Номенклатура	Внутренний диаметр, мм	Внешний диаметр, мм	Высота, мм
504410	1,4	2,8	3
507700	1,4	2,8	5
500600	1,5	4	4
503100	1,5	4,5	10
504390	1,8	4,5	4,5
500100	2	6	4
501000	2	4	4
502900	2	4	6
504590	2	5	6
505190	2,15	5	5
500500	5,5	10,5	9
501400	5,5	7,9	7,6
501800	6	10	10
502290	6	10	7,5
501600	7,5	13	9
500800	8,5	16,5	10

502300	2,2	5	3
502790	2,3	5	5,3
504290	2,3	5,3	8
500700	2,5	5	5
501100	2,7	6	6,5
501700	3	9	9
500200	3,5	7	7
500900	3,5	6	5,5
500300	4	8	8
501200	4	6,5	5
502090	4	6,5	7
500400	4,5	9	8,5
501300	4,6	6,9	6,7
504990	4,6	6,9	6,7
501900	5	7,5	7,1
503300	5,2	9,5	8

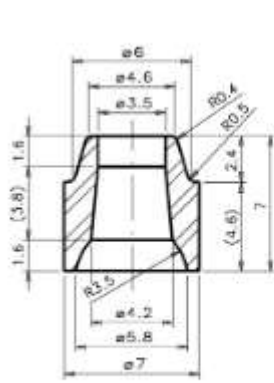

500200

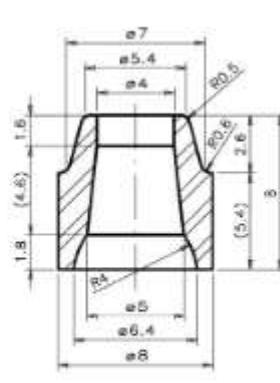

500300

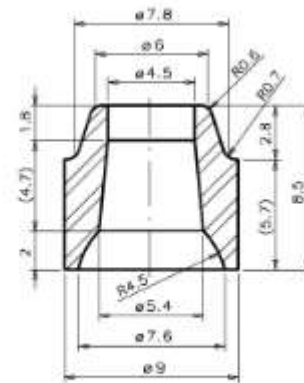

500400

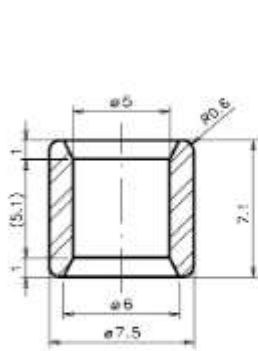

501900

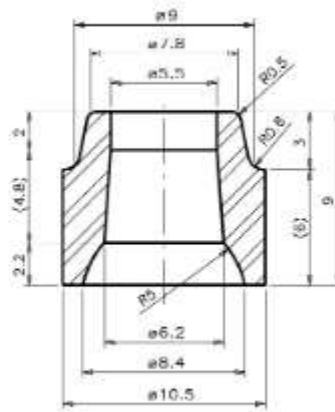

500500

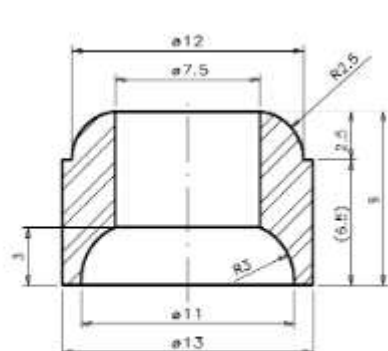

501600

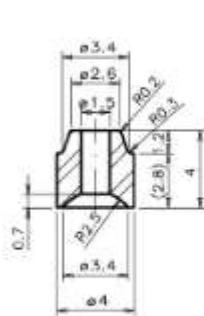

500600

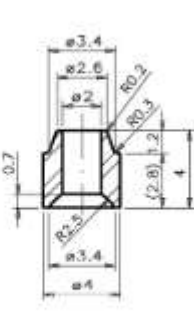

501000

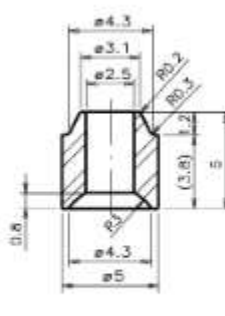

500700

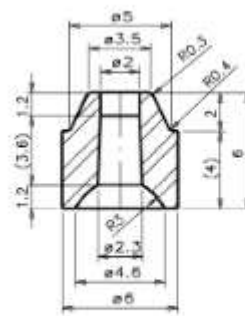

500100

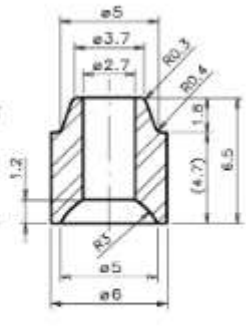

501100

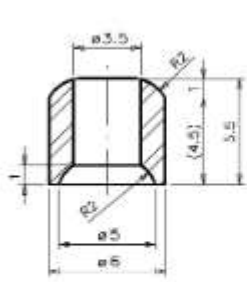

500900

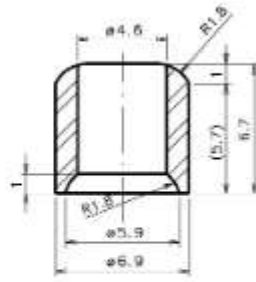

501300

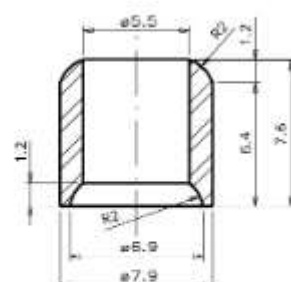

501400

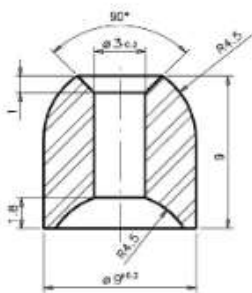

501700

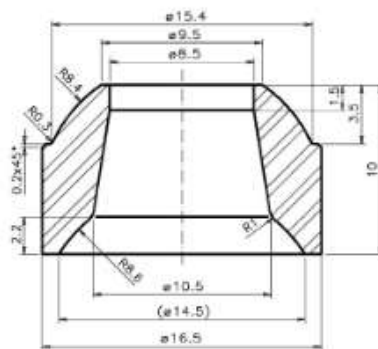

500800

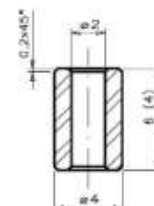

502900

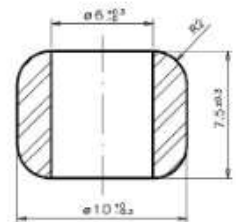

502290

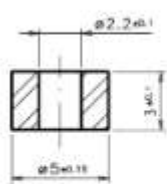

502300

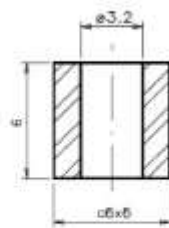

501500

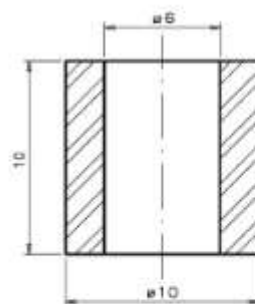

501800

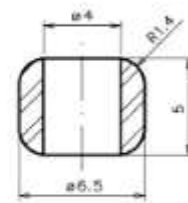

501200